



Home Phone Networking Filter Module

Designed For Use With AMD's 79C978 Phonenumber Ethernet LAN Controller Support TUT System Home Run Technology.
 Excellent Impedance Matching And EMI Filtering.
 Available In Through Hole And Surface Mount Packages.
RoHS " -R " peak solder rating 260°C, non-RoHS peak solder rating 225°C
 For RoHS part, add suffix **-R**

ELECTRICAL SPECIFICATIONS @ 25°C - Operating Temperature 0°C - 70°C

Part Number	Insertion Loss (dB max)			Attenuation (dB min)		Return Loss (dB min)	Isolation Vrms
	6 MHz	7.5Mz	9Mz	1MHz	27 MHz	(6MHz □ 9MHz)	
M16101DH M16101DH	-4.0	-3.5	-4.0	-50	-50	-10	2000
M16101MM M16101MM	-4.0	-3.5	-4.0	-50	-50	-10	2000
M16101DG M16101DG	-4.0	-3.5	-4.0	-5.0	-50	-10	2000

SCHEMATICS

M16101DH, M16101MM, M16101DG
M16101DH-R, M16101MM-R, M16101DG-R

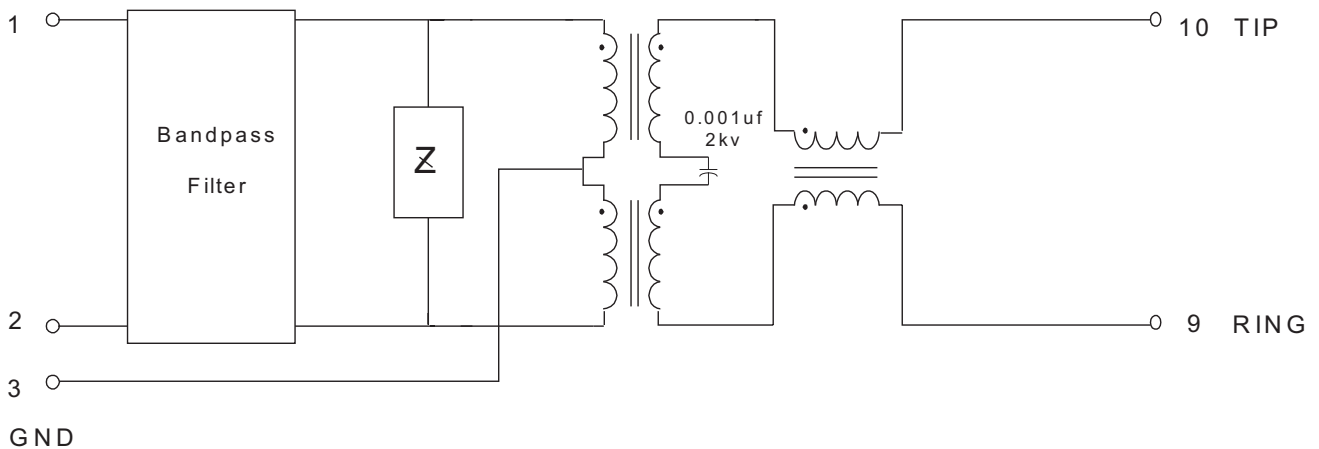

Specifications Subject To Change Without Notice

TAIWAN
 TEL: 00886-3-3310896
 FAX: 00886-3-3310865

DONGGUAN
 TEL: 086-769-86761589
 FAX: 086-769-86761549



Home Phone Networking Filter Module

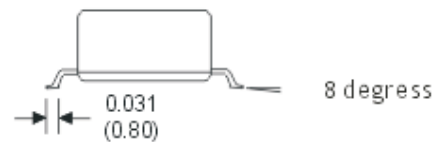
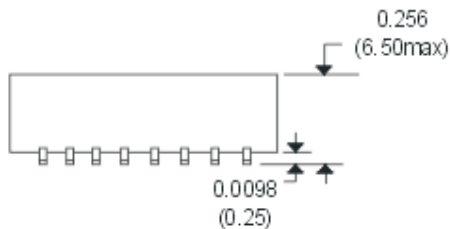
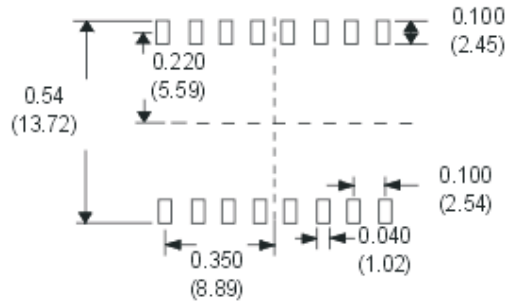
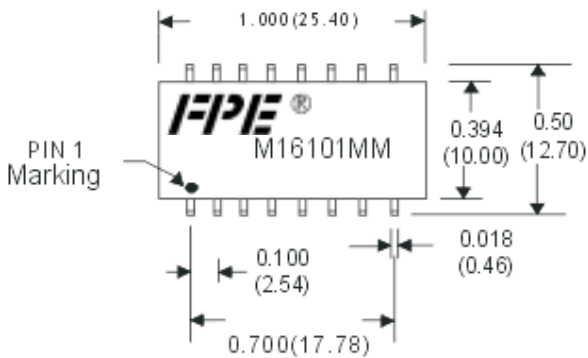
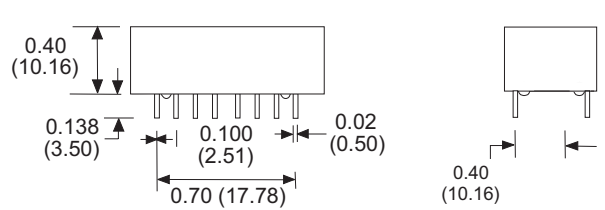
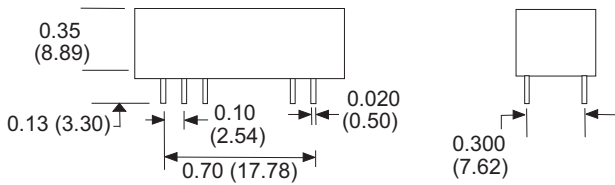
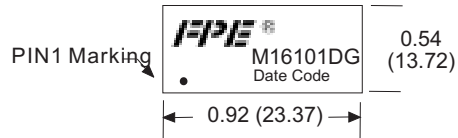
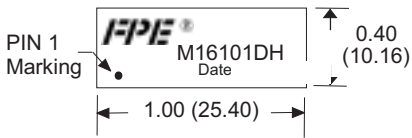

Specifications Subject To Change Without Notice

TAIWAN
 TEL: 00886-3-3310896
 FAX: 00886-3-3310865

DONGGUAN
 TEL: 086-769-86761589
 FAX: 086-769-86761549