

Common Mode Filter

- ◆ High common mode impedance at high frequency Effects excellent noise suppression performance
- ◆ 100% Lead(Pb) & Halogen-Free and RoHS compliant.
- ◆ FOR LAN Module application



ELECTRICAL SPECIFICATIONS@25°C (Operating temperature-40~+105°C (Including self - temperature rise))

Part Number	Inductance(uH) [100kHz/0.1V] Min.	DC Resistance (Ω)Max.	Capacitance (pF)Max	Rated Current (mA)Max.	Rated Volt. (Vdc)	Withstand Volt. (Vdc) Max.	IR(Ω) Min.
GN3416F-200L	20	1.1	15	200	50	125	10M

MECHANICAL

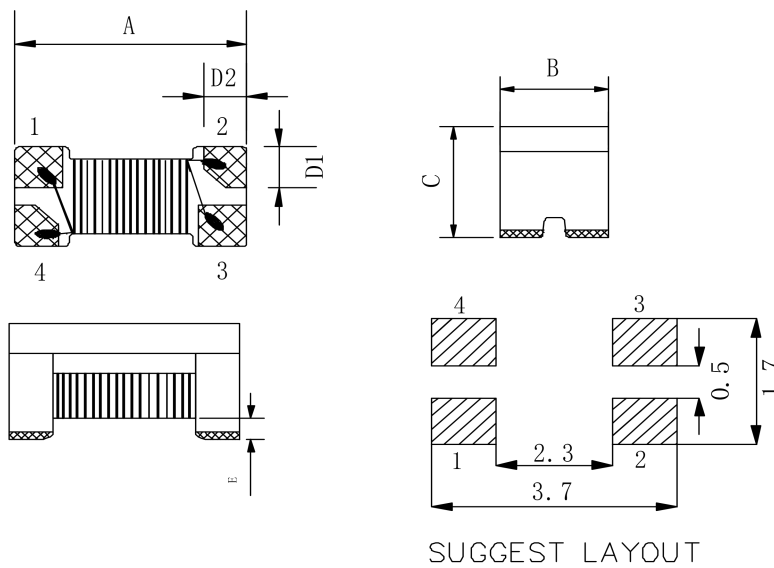

Part Number	A(mm)	B(mm)	C(mm)	D1(mm)	D2(mm)	E(mm)
GN3416F-200L	3.4±0.20	1.6±0.20	2.0±0.20	0.66±0.10	0.64±0.10	0.27 REF

SCHEMATICS

